

TurboTron®

Regenerative Blower/Exhauster



LAMSON 
A GARDNER DENVER PRODUCT

HOFFMAN 
A GARDNER DENVER PRODUCT

GD
GARDNER DENVER

Experience Proven Results™

Full Flow and Half Flow Regenerative Blowers/Exhausters

The patented TurboTron® Regenerative Full Flow and Half Flow blowers/exhausters are specifically designed to provide continuous flow and pulse-free air, with the versatility to perform in numerous air applications. These regenerative blowers/exhausters are packaged in various pre-engineered “TurboPak” systems and are available as belt drive, direct drive, overhung and even VFD variable speed configurations. Its unique capabilities make the TurboTron Regenerative blower the choice in applications from wastewater treatment aeration and pneumatic conveying to chemical tank agitation and vacuum cleaning. Typical industries for TurboTron Regenerative blowers include foundries, plating, plastics, pharmaceutical, pulp and paper and printing.

Key Features

Installed as a blower or exhauster, the TurboTron Regenerative unit features a revolutionary impeller design, achieving multistage compression with a single impeller. This unique design represents the best efficiency available in a regenerative blower/exhauster. The TurboTron Regenerative blower delivers quiet, clean, smooth, pulse-free air with pressures to 13 psig and vacuum to 14 "Hg.

Quiet and Noise Free – Noise and vibration are reduced. Even without an acoustical cover, the typical free field noise level is only 82 dBA at three feet (one meter).

Trouble-Free – This Regenerative blower/exhauster is virtually maintenance free. There is only one moving part and no timing gears. The high tensile strength aluminum composite housing is corrosion resistant. Non-binding Teflon® is used in close tolerance areas. Bearings require only occasional greasing, and shaft seals are non-contacting and non-wearing.

Value – A revolutionary design, proven dependability and power make this blower/vacuum producer the best investment for the most demanding applications. Application assistance is available by contacting your local Gardner Denver representative.

Full Flow Series

- Airflow to 900 cfm
- Pressure to 13 psig
- Vacuum to 14 "Hg

Half Flow Series

- Airflow to 450 cfm
- Pressure to 13 psig
- Vacuum to 14 "Hg



Revolutionary Design

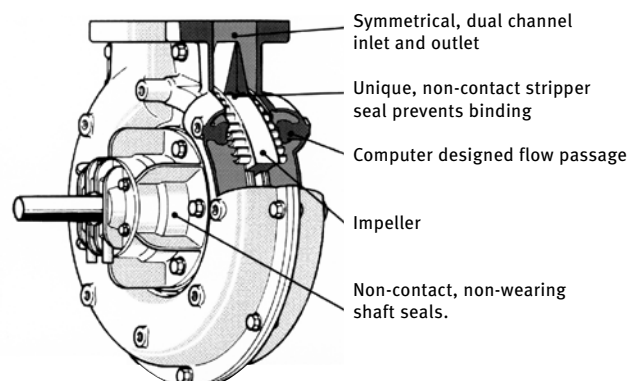

TurboPak

Engineered Systems

The Gardner Denver® Full Flow and Half Flow TurboPak™ A, C and VFD are pre-engineered packages that include a patented TurboTron Regenerative blower/exhauster assembled with a motor on a heavy duty platform.

TurboPak™ A – Regenerative Blower/Exhauster Systems

TurboPak A is the economical and proven way to provide a constant flow of air at varying pressures.

TurboPak™ C – Regenerative Blower/Exhauster Systems

TurboPak C adds a silencer base with integrated inlet and discharge silencers for improved sound attenuation.

TurboPak™ VFD Variable Speed Regenerative Blower/Exhauster System

The Gardner Denver TurboPak VFD is designed to greatly improve turndown capability at very low overall cost. The TurboPak VFD is particularly well suited to the varying air demands of post aeration in wastewater treatment plants.

TurboPak™ VFD – value

A TurboPak VFD was teamed with a small multistage centrifugal blower and compared to four other scenarios to determine the lowest overall cost option for a post aeration project in New Jersey. The following table summarizes how the TurboPak VFD/Multistage option was the most cost effective with the highest turndown ratio based on 2200 SCFM/6 psig.

	Min Power (bhp)	Max Power (bhp)	Overall Turndown (%)	% Cost
TurboPak VFD and Multistage	17.0	100.9	92	100
Single Multistage	55.8	93.2	50	129
Two Multistage	36.8	109.0	70	136
Three Multistage	21.2	103.5	86	133
Single Multistage with VFD	34.3	114.3	64	173

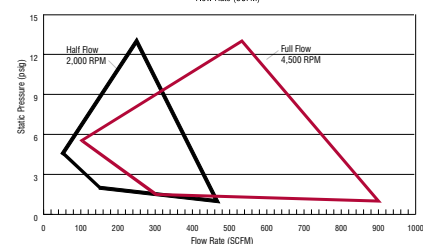
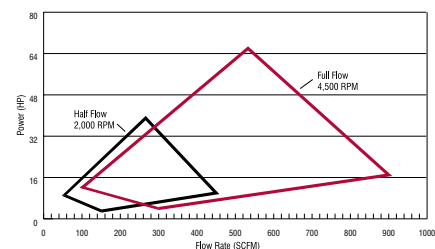
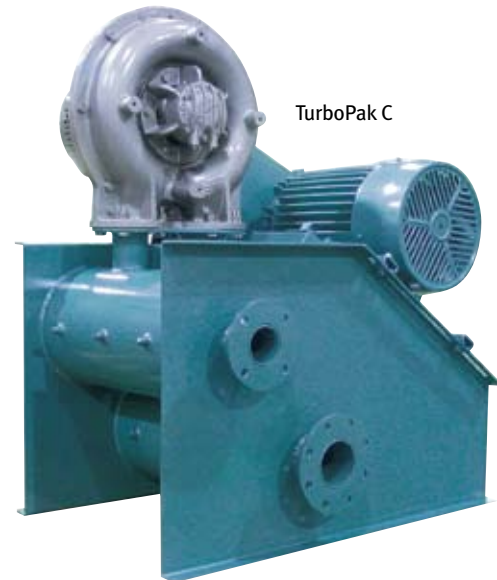
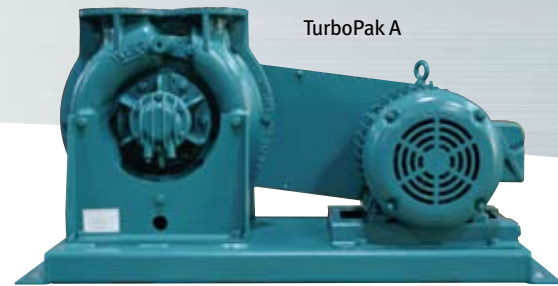

TurboTron Regenerative Blower/Exhauster

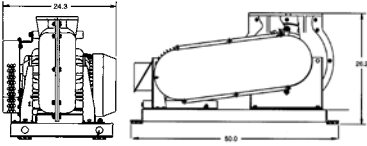
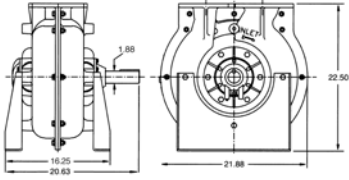

TurboPak C

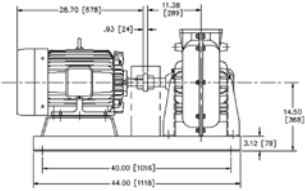
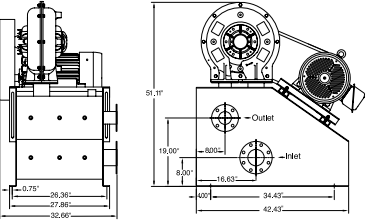

TurboPak VFD

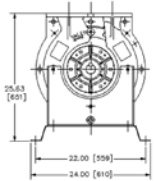

FULL FLOW



Half Flow Impeller

Pressure (psig)

RPM		2	3	4	5	6	7	8	9	10	11	12	13
2000	SCFM	262	211	164	120								
	HP	5.1	7.1	9.1	11.1								
2800	SCFM	458	415	374	333	295	257	221					
	HP	9.0	11.7	14.3	17.0	19.7	22.5	25.2					
3700	SCFM	668	629	591	555	520	486	454	423	393	364		
	HP	15.3	18.9	22.4	22.8	29.3	32.9	36.6	40.4	44.1	47.6		
4500	SCFM	858	817	780	745	713	682	653	626	600	575	552	529
	HP	22.8	27.4	31.7	35.9	40.1	44.3	48.6	52.9	57.3	61.6	66.0	70.2

Vacuum ("Hg)

RPM		3	4	5	6	7	8	9	10	11	12	13	14
2000	SCFM	258	217	179	143	109	77						
	HP	3.8	4.8	5.8	6.8	7.7	8.7						
2800	SCFM	428	393	352	312	274	235	199	163	128			
	HP	7.0	8.0	9.3	10.5	11.7	13.0	14.2	15.6	16.9			
3700	SCFM	630	583	536	490	446	402	359	318	278	239		
	HP	10.8	12.8	14.5	16.1	17.7	19.2	20.7	22.4	24.1	25.8		
4500	SCFM	810	757	702	648	596	546	498	452	407	364	323	283
	HP	15.7	18.0	20.3	22.3	24.2	26.0	27.8	29.5	31.3	33.2	35.0	36.7

Pressure (psig)

RPM		2	3	4	5	6	7	8	9	10	11	12	13
2000	SCFM	131	105	82	60								
	HP	2.8	3.9	5.0	6.1								
2800	SCFM	229	208	187	167	147	129	111					
	HP	5.0	6.4	7.9	9.3	10.8	12.3	13.9					
3700	SCFM	334	314	295	277	260	243	227	211	196	182		
	HP	8.4	10.4	12.3	14.2	16.1	18.1	20.1	22.2	24.3	26.2		
4500	SCFM	429	409	390	373	356	341	327	313	300	288	276	265
	HP	12.5	15.1	17.4	19.7	22.0	24.3	26.7	29.1	31.5	33.9	36.3	38.6

Vacuum ("Hg)

RPM		3	4	5	6	7	8	9	10	11	12	13	14
2000	SCFM	129	109	90	71	55	39						
	HP	2.1	2.6	3.2	3.7	4.2	4.8						
2800	SCFM	214	197	176	156	134	118	99	81	64			
	HP	3.9	4.4	5.1	5.8	6.4	7.1	7.8	8.6	9.3			
3700	SCFM	315	291	268	245	223	201	180	159	139	119		
	HP	5.9	7.0	8.0	8.9	9.7	10.6	11.4	12.3	13.2	14.2		
4500	SCFM	4.5	378	351	324	298	273	249	226	203	182	161	141
	HP	8.6	9.9	11.2	12.3	13.3	14.3	15.3	16.2	17.2	18.2	19.2	20.2

Performance data for air at standard conditions: Sea level, 14.7 PSIA, 29.92 "Hg, 68°F inlet temperature, 36% relative humidity.



www.GardnerDenverProducts.com cf.blowers@gardnerdenver.com

Gardner Denver, Inc. 100 Gardner Park, Peachtree City, GA 30269

New Equipment Sales: (800) 543-7736 Phone: (770) 632-5000 Fax: (700) 486-5628

Aftermarket Parts Sales: (800) 982-3009 Phone: (770) 632-5000 Fax: (700) 486-5530



Member

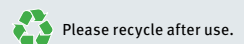

Specifications subject to change without notice

©2010 Gardner Denver, Inc. Litho in U.S.A.

GDCF-1-250- 2nd Ed. 01/10